



## Compendium of DMS Series

**Three types of sensors**

<b>General type(DMS)</b>	<b>Waterproof type(Yellow)</b>
General type(Aqua Blue)	Waterproof type(Yellow)
<b>Manipulator industry(A05-DMS)</b>	<b>Oil resistance and deflection resistance (A06-DMS)</b>
Product characteristics: 1. Flexure resistant curve material can be used in manipulator industry, such as multi joint manipulator and tank chain. 2. In case of high temperature, much dust, or water droplets and oil dust, the sensor shall take corresponding dust-proof measures.	Product characteristics: 1. Flexure resistant curve material can be used in manipulator industry, such as multi joint manipulator and tank chain. 2. In case of welding slag, corresponding protective measures shall be taken for the sensor.
<b>High deflection wire</b>	<b>Oil resistant and flexural curve material</b>
The deflection is increased by about 20% compared with the general type	The deflection is increased by about 20% compared with the general type. It can be used in oil dust environment.
	<b>Waterproof design(IP68)</b>

Note: The recommended minimum bending radius of A05-DMS, A06-DMS cables is 19mm.

**Bending resistance**

**SR: bending resistance**

**Impact resistant materials**

**Two kinds of accessories**

DMSG can be mounted with 2 accessories, applicable to multi-cylinders.

<b>DMSG</b>	<b>F-MQ</b>
	<b>F-SC=SH</b>

### Four types of cross section

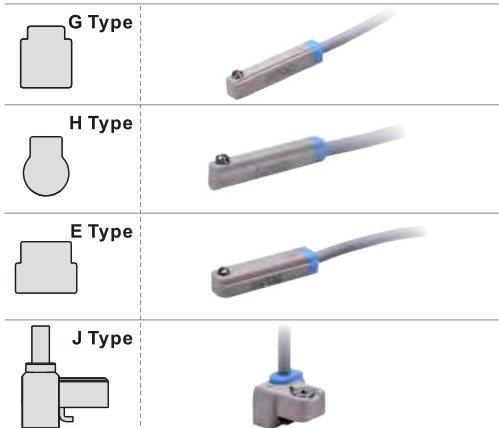

### DMS Specifications

Item	DMS		
	2-wire	NPN	PNP
Model			
Power supply voltage	10V ~ 28V DC	5V ~ 30V DC	
Switching current	2.5mA ~ 100mA	30V/200mA Max.	
Contact capacity	2.8W Max.	6.0W Max.	
Current consumption	3mA Max.	5mA Max.	
Internal voltage drop	3.5V Max.	0.7V Max.	
Leakage current	0.05mA Max.	0.01mA Max.	
Switching frequency	1000Hz		
Impact resistance	50G		
Circuit protection	Reverse polarity protection Surge protection		
Operating Temp.	-10°C ~ 70°C		
Enclosure	DMS, A05-DMS: IP64 / A06-DMS: IP68		
Standard	CE marking, RoHS		

[Note] A05 \ A06 type has only two-wire type.

### Ordering code for DMS

<b>DMS G - □ 020 - □</b>						
<b>A05-DMS G - □ 020</b>						
<b>A06-DMS G - □ 020</b>						
①	②	③	④	⑤	⑥	
① Industry code	Blank: General type A05: Manipulator industry A06: Oil resistance and deflection resistance					
② Model	DMS : Solid State Sensor					
③ Specifications	G H E J [Noet1]					
④ Output type	Blank: 2 wire N : NPN [Noet2] P : PNP					
⑤ Lead wire	Direct lead wire					
	020: 2m 030: 3m 050: 5m 100: 10m					
⑤ Lead wire	Plug connector [Noet3]					
	M08: 0.5m with M8 plug connector M12: 0.5m with M12 plug connector M08010: 1m with M8 plug connector M12010: 1m with M12 plug connector M08020: 2m with M8 plug connector M12020: 2m with M12 plug connector M08030: 3m with M8 plug connector M12030: 3m with M12 plug connector					
⑥ Additional specification	Blank: General type W: Waterproof type IP68 [note4]					

[Note1] Type J is not available for A06. [Note2] A05 and A06 have no NPN and PNP option. [Note3] A05 and A06 have no plug connector option. [Note4] A05, J type and M08, M12 don't have a-w Waterproof option. Standard A06 model already has a waterproof function. Add: The sockets of M08 and M12 need additional order. Please check on page 374.





## Compendium of EMS Series

**Three types of sensors**

<b>General type(EMS)</b>	<b>Waterproof type(Yellow)</b>
General type(Aqua Blue)	Waterproof type(Yellow)
<b>Manipulator industry(A05-EMS)</b>	<b>Oil resistance and deflection resistance (A06-EMS)</b>
<p>Product characteristics:</p> <ol style="list-style-type: none"> <li>1. Flexure resistant curve material can be used in manipulator industry, such as multi joint manipulator and tank chain.</li> <li>2. In case of high temperature, much dust, or water droplets and oil dust, the sensor shall take corresponding dust-proof measures.</li> </ol>	<p>Product characteristics:</p> <ol style="list-style-type: none"> <li>1. Flexure resistant curve material can be used in manipulator industry, such as multi joint manipulator and tank chain.</li> <li>2. In case of welding slag, corresponding protective measures shall be taken for the sensor.</li> </ol>
<b>High deflection wire</b>	<b>Oil resistant and flexural curve material</b>
The deflection is increased by about 20% compared with the general type	The deflection is increased by about 20% compared with the general type. It can be used in oil dust environment.
	<b>Waterproof design(IP68)</b>

**Bending resistance**

**SR: bending resistance**

**Impact resistant materials**

**High cylinder installation flexibility**

EMSG is the mini type corresponding to DMSG, which can be used for long and short strokes. EMSH is the mini type corresponding to DMSH, which can be used for long and short strokes.

Note: The recommended minimum bending radius of A05-EMS, A06-EMS cables is 19mm.

### Two types of cross section

<b>G Type</b>	General type(Aqua Blue)	Waterproof type(Yellow)
<b>H Type</b>	General type(Aqua Blue)	Waterproof type(Yellow)

### EMS Specifications

Item	EMS
Model	2-wire
Power supply voltage	10V ~ 28V DC
Switching current	2.5mA ~ 100mA
Contact capacity	2.8W Max.
Current consumption	3mA Max.
Internal voltage drop	3.5V Max.
Leakage current	0.06mA Max.
Switching frequency	1000Hz
Impact resistance	50G
Circuit protection	Reverse polarity protection Surge protection
Operating Temp.	-10°C ~ 70°C
Enclosure	EMS, A05-EMS: IP64 / A06-EMS: IP68
Standard	CE marking, RoHS
Note	Temperature overheat protection

### Ordering code for EMS

EMS G - □ 020 - □	
A05-EMS G - □ 020	
A06-EMS G - □ 020	

① ② ③ ④ ⑤ ⑥

① Industry code	Blank: General type A05: Manipulator industry    A06: Oil resistance and deflection resistance
② Model	EMS : Solid State Sensor
③ Specifications	G    H
④ Output type	Blank: 2 wire
⑤ Lead wire	Direct lead wire
	Plug connector [Noet1]
⑥ Additional specification	Blank: General type    W: Waterproof type IP68 [note2]

M08    M12

[Note1] A05 and A06 have no plug connector option. [Note2] A05 and A06 don't have a-w Waterproof option. Standard A06 model has a waterproof function. Add: The sockets of M08 and M12 need additional order. Please check on page 374.





## Compendium of CMS Series

**Two types of sensors**

**General type(CMS)**

General type(blue) High temperature type (red)

**Manipulator industry(A05-CMS)**

Product characteristics:

1. Flexure resistant curve material can be used in manipulator industry, such as multi joint manipulator and tank chain.
2. In case of high temperature, much dust, or water droplets and oil dust, the sensor shall take corresponding dust-proof measures.

**High deflection wire**

The deflection is increased by about 20% compared with the general type

**Bending resistance**

**SR: bending resistance**

**Impact resistant materials**

**Two kinds of accessories**

CMSG can be mounted with 2 accessories, applicable to multi-cylinders.

### Four types of cross section

<b>G Type</b>		
<b>H Type</b>		
<b>E Type</b>		
<b>J Type</b>		

CMSG	F-MQ	
	F-SC=SH	

### CMS Specifications

Item	CMS	
	General	Heat resistant
Model	General	Heat resistant
Power supply voltage	5V ~ 240V AC/DC	
Switching current	100mA	
Contact capacity	10W Max.	
Current consumption	N/A	
Internal voltage drop	2.5V Max. @100mA DC	N/A
Leakage current	N/A	
Switching frequency	200Hz	
Impact resistance	50G	
Circuit protection	N/A	
Operating Temp.	-10°C ~ 70°C	-10°C ~ 125°C
Enclosure	IP64	
Standard	CE marking, RoHS	

### Ordering code for CMS

**CMS G - 020 - □**

**A05-CMS G - 020**

① ② ③ ④ ⑤

① Industry code	Blank: General type    A05: Manipulator industry
② Model	CMS : Reed Sensor
③ Specifications	G    H    E    J
④ Lead wire	Direct lead wire
	Plug connector [Noet1]
⑤ Additional specification	Blank: General type    H:Heat resistant [note2]

020: 2m    030: 3m    050: 5m    100: 10m

M08:0.5m with M8 plug connector    M12:0.5m with M12 plug connector  
M08010:1m with M8 plug connector    M12010:1m with M12 plug connector  
M08020:2m with M8 plug connector    M12020:2m with M12 plug connector  
M08030:3m with M8 plug connector    M12030:3m with M12 plug connector

[Note1]A05 has no plug connector option. [Note2]A05 has no heat resistant option.  
Add:The sockets of M08 and M12 need additional order. Please check on page374.



### Ordering code for accessories

#### F - MQ □ Cylinder Accessory

① ② ③



① Category	F : Accessory								
② Model	MQ : Cylinder Accessory								
③ Cylinder	Aluminum alloy			Aluminum alloy (Thick type)			Stainless steel		
	Code	For series	For bore size	Code	For series	For bore size	Code	For series	For bore size
	A20: Φ20mm		Φ20	A32T: Φ32mm		Φ32	S06: Φ6mm		Φ6
	A25: Φ25mm		Φ25	A40T: Φ40mm	TWG	Φ40	S08: Φ8mm		Φ8
	A32: Φ32mm	MCK	Φ32	A50T: Φ50mm		Φ50	S10: Φ10mm		Φ10
	A40: Φ40mm	MBL	Φ40				S12: Φ12mm	PB/PBR	Φ12
	A50: Φ50mm		Φ50				S16: Φ16mm	MI	Φ16
	A63: Φ63mm		Φ63				S20: Φ20mm	MF	Φ20
	A80: Φ80mm		Φ80				S25: Φ25mm	MG	Φ25
							S32: Φ32mm	MA/MAC	Φ32
						S40: Φ40mm		Φ40	
						S50: Φ50mm		Φ50	
						S63: Φ63mm		Φ63	

#### F - SC □ SH Tie Rod Cylinder Accessory

① ② ③ ④



① Category	F : Accessory		
② Model	SC : Tie Rod Cylinder Accessory		
③ Cylinder	Code	For series	For bore size
	32		Φ32, Φ40
	50		Φ50
	63		Φ63
	80	SC	Φ80, Φ100
	125	SGC	Φ125
	160		Φ160, Φ200
	250		Φ250
④ Attached			

## DMS, EMS, CMS Series

### Dimensions

#### DMSG/CMSG Type

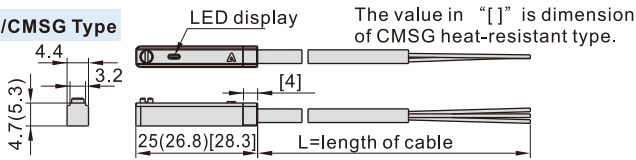

Note: The value in “( )” is dimension of CMSG type.

#### DMSE/CMSE Type

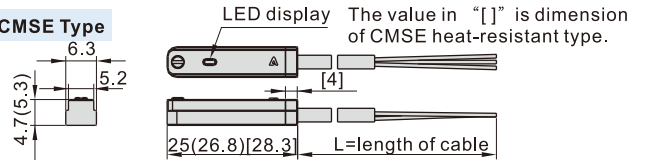

Note: The value in “( )” is dimension of CMSE type.

#### DMSH/CMSH Type

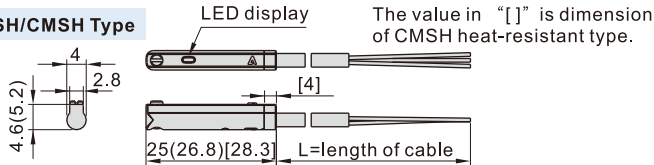

Note: The value in “( )” is dimension of CMSH type.

#### EMSG Type

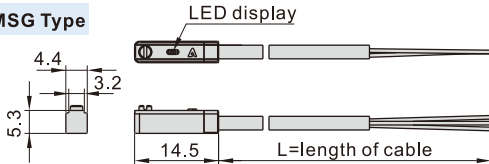

Note: a number in the bracket is the dimension of CMSH.

#### EMSH Type

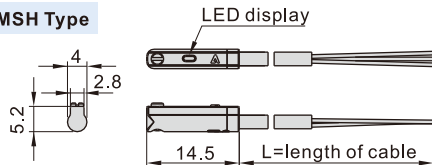

#### CMSJ Type

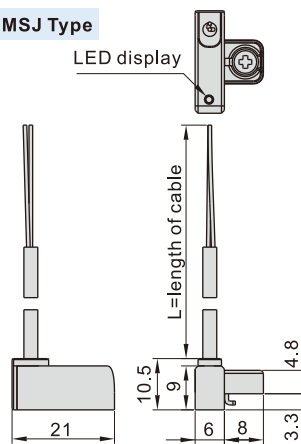

#### DMSJ Type

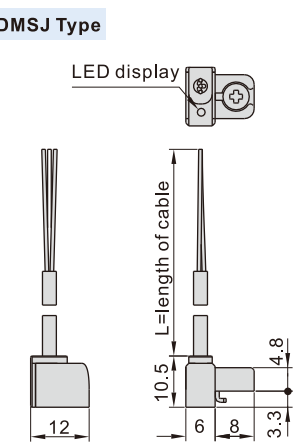

length of cable specification	length of cable(L)
020 Type	2000mm
030 Type	3000mm
050 Type	5000mm

### Connection method

#### 2 wire, reed sensor connection

##### 1.General connection

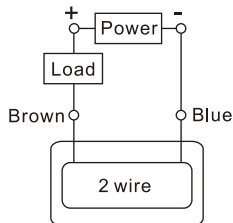

##### 2.Series connection(And)

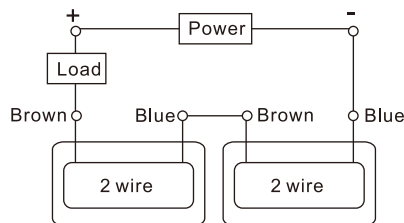

##### 3.Parallel connection(OR)

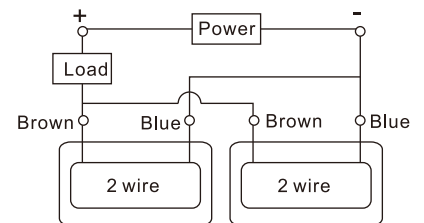

#### 3 wire, solid state NPN connection

##### 1.General connection

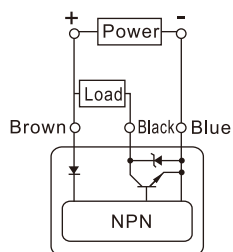

Note: The indicator lights will light up when both auto switches are turned NO.

##### 2.Series connection(And)

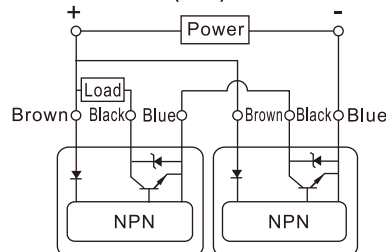

##### 3.Parallel connection(OR)

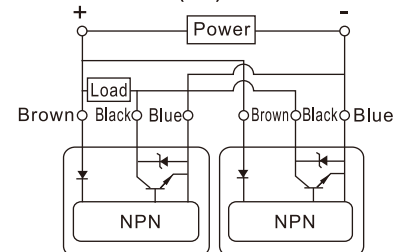

#### 3 wire, solid state PNP connection

##### 1.General connection

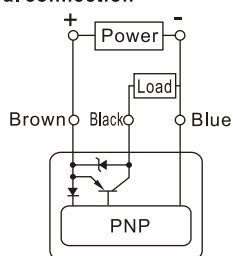

Note: The indicator lights will light up when both auto switches are turned NO.

##### 2.Series connection(And)

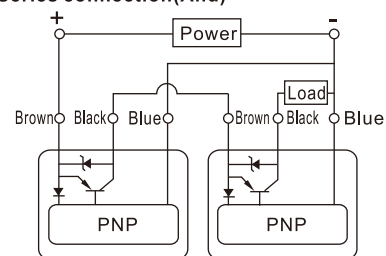

##### 3.Parallel connection(OR)

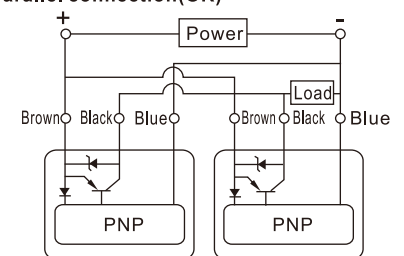

### The selection of sensor

DMSG	CMSG	EMSG	HFKL				MCK				ACQ/TACQ								ACQ			RMTL	RMT	RMTL	SDA/RMT/RMTL				SDA						
			10	16	20	25	25	32	40	50	63	80	12	16	20	25	32	40	50	63	80	100	125	140	160	10	16	20	25	32	40	50	63	80	100
			•	•	•	•	•	•	•	•	•	•	•	•	•	•	•	•	•	•	•	•	•	•	•	•	•	•	•	•	•	•	•	•	
			HFK		HFK/HFKP		HFK		TCL/TCM								QCK				TR														
			10	16	20	25	32	40	6	10	12	16	20	25	32	40	50	63	80	100	12	16	20	25	32	40	50	63	6	10	16	20	25	32	
			•	•	•	•	•													•	•	•	•	•	•	•	•	•	•	•	•	•	•	•	•
			SAU				HFZ				HFY				HFP				MD/MK				AQK/BAQK												
			32	40	50	63	80	100	6	10	16	20	25	32	40	6	10	16	20	25	32	10	16	20	25	32	6	10	16	20	25	32	50		
			•	•	•	•	•													•	•	•	•	•	•	•	•	•	•	•	•	•	•	•	•

		Stainless steel																														
		PB/PBR				MI		MI/TMI				MI		MF				MG				MA/MAC										
		6	8	10	12	16	8	10	12	16	20	25	32	40	20	25	32	40	20	25	32	40	50	63	16	20	25	32	40	50	63	
		•	•	•	•	•	•	•	•	•	•	•	•	•	•	•	•	•	•	•	•	•	•	•	•	•	•	•	•	•	•	•
		Aluminum alloy																														
		MBL					MCK																									
		20	25	32	40	50	63	40	50	63	80																					
		•	•	•	•	•	•	•	•	•	•																					

It needs an accessory to mount a sensor on a cylinder

		SC										SGC			
		32	40	50	63	80	100	125	160	200	250	125	160	200	250
		•	•	•	•	•	•	•	•	•	•	•	•	•	•



It needs an accessory to mount a sensor on a cylinder

DMSJ	CMSJ	ACQ/TACQ								SDA								QCK				QDK				TN					
		32	40	50	63	80	100	12	16	20	25	32	40	50	63	80	100	32	40	50	63	20	25	32	40	10	16	20	25	32	
		•	•	•	•	•	•	•	•	•	•	•	•	•	•	•	•	•	•	•	•	•	•	•	•	•	•	•	•	•	•

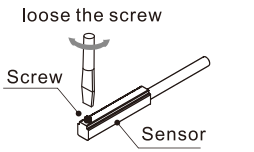
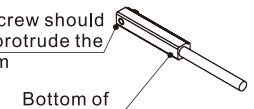
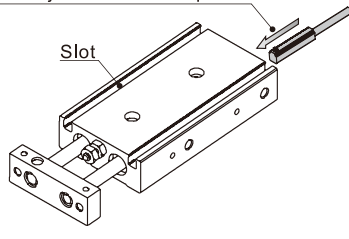
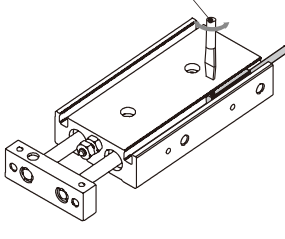
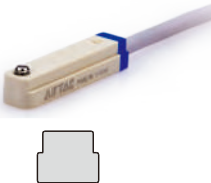
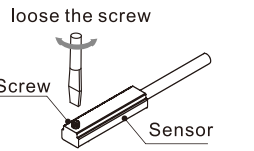
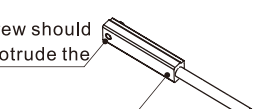
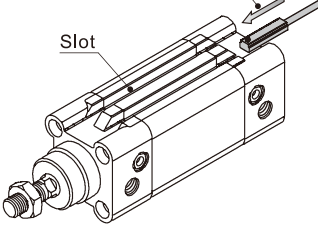
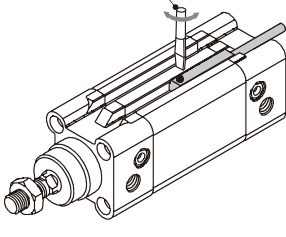

DMSH	CMSH	EMSH	ACQ		TC		HFZ				HFY		HFP				HFR				HFC				HFT										
			125	140	160	6	10	6	10	16	20	25	32	40	6	32	10	16	20	25	32	16	20	25	32	40	50	63	10	16	20	25	32		
			•	•	•	•	•	•	•	•	•	•	•	•	•	•	•	•	•	•	•	•	•	•	•	•	•	•	•	•	•	•	•		
			QDK				HLQ/HLQL				HLS/HLSL				MU				HLH				MPG												
			20	25	32	40	6	8	12	16	20	25	6	8	12	16	20	25	6	8	10	12	16	20	6	10	16	20	6	8	10	12	16		
			•	•	•	•	•	•	•	•	•	•	•	•	•	•	•	•	•	•	•	•	•	•	•	•	•	•	•	•	•	•	•		
			HRQ				HFK				HLF				HGS				RMH				HFD												
			2	3	7	10	20	30	50	70	100	200	10	16	20	25	32	40	8	12	16	20	6	8	10	12	10	16	20	25	8	12	16	20	25
			•	•	•	•	•	•	•	•	•	•	•	•	•	•	•	•	•	•	•	•	•	•	•	•	•	•	•	•	•	•	•	•	•
			HFKL		HFCQ				HRS				HFKP																						
			10	16	20	25	16	20	25	32	40	50	63	10	15	20	30	40	16	20	25	32													
			•	•	•	•	•	•	•	•	•	•	•	•	•	•	•	•	•	•	•	•													

DMSE	CMSE	ACF				SAI/TSAI				SAI				ACE				ACE/JSI													
		12	16	20	25	32	40	50	63	32	40	50	63	80	100	125	160	200	12	16	20	25	32	40	50	63	80	100	125		
		•	•	•	•	•	•	•	•	•	•	•	•	•	•	•	•	•	•	•	•	•	•	•	•	•	•	•	•	•	•

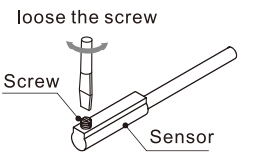
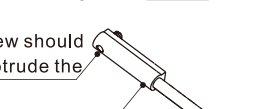
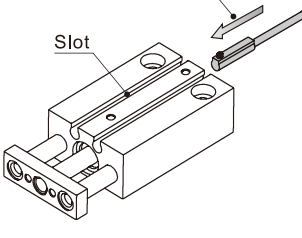
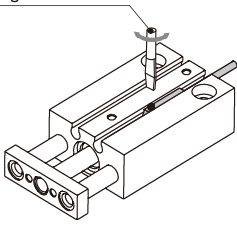
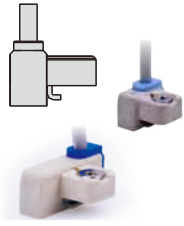
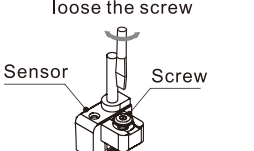
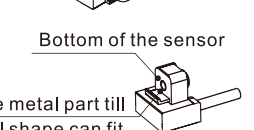
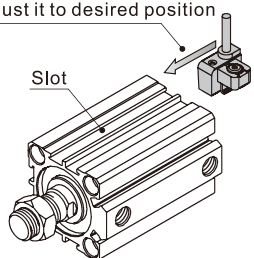
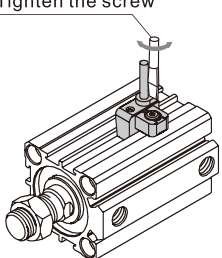
### Installation

Sensor model	Procedure		
<p><b>DMSG/CMMSG/EMSG</b></p> 	<p><b>1</b></p> <p>loose the screw</p>  <p>Screw</p> <p>Sensor</p> <p>The screw should NOT protrude the bottom</p>  <p>Bottom of the sensor</p>	<p><b>2</b></p> <p>Insert the sensor into the slot and adjust it to desired position</p>  <p>Slot</p>	<p><b>3</b></p> <p>Tighten the screw</p> 
<p><b>DMSE/CMSE</b></p> 	<p><b>1</b></p> <p>loose the screw</p>  <p>Screw</p> <p>Sensor</p> <p>The screw should NOT protrude the bottom</p>  <p>Bottom of the sensor</p>	<p><b>2</b></p> <p>Insert the sensor into the slot and adjust it to desired position</p>  <p>Slot</p>	<p><b>3</b></p> <p>Tighten the screw</p> 
<p><b>DMSH/CMSh/EMSH</b></p> 	<p><b>1</b></p> <p>loose the screw</p>  <p>Screw</p> <p>Sensor</p> <p>The screw should NOT protrude the bottom</p>  <p>Bottom of the sensor</p>	<p><b>2</b></p> <p>Insert the sensor into the slot and adjust it to desired position</p>  <p>Slot</p>	<p><b>3</b></p> <p>Tighten the screw</p> 
<p><b>DMSJ/CMsj</b></p> 	<p><b>1</b></p> <p>loose the screw</p>  <p>Sensor</p> <p>Screw</p> <p>Bottom of the sensor</p> <p>Adjust the metal part till the lateral shape can fit the slot of the cylinder</p> 	<p><b>2</b></p> <p>Insert the sensor into the slot and adjust it to desired position</p>  <p>Slot</p>	<p><b>3</b></p> <p>Tighten the screw</p> 

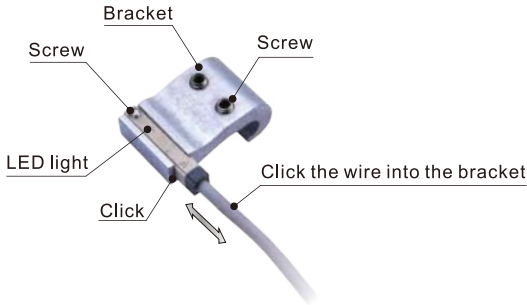
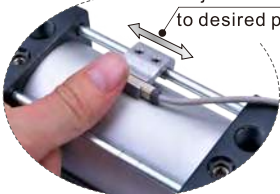
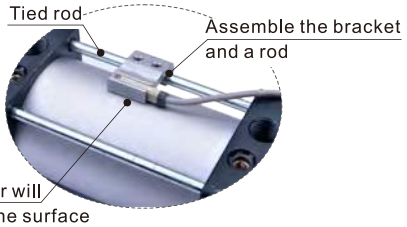
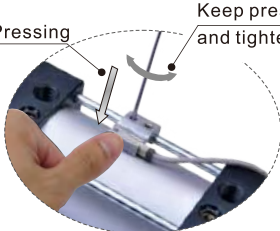

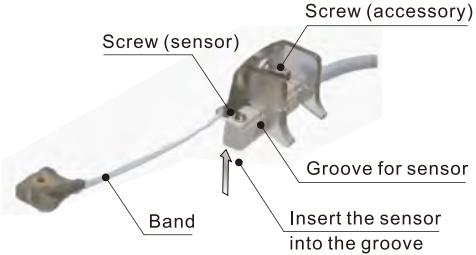
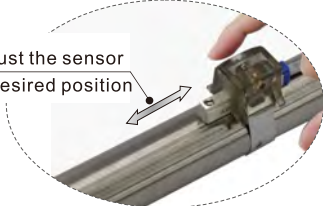
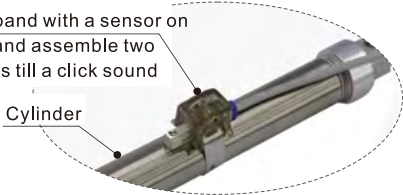
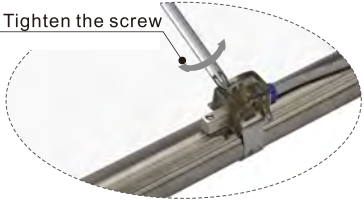



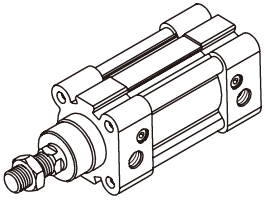

## DMSG, EMS, CMS Series

Sensor model	Procedure	
<p>DMSG+(F-SC□SH) CMSG+(F-SC□SH)</p> 	<p><b>1</b></p>  <p><b>3</b></p> 	<p><b>2</b></p>  <p><b>4</b></p> 
<p>DMSG+(F-MQ□) CMSG+(F-MQ□)</p> 	<p><b>1</b></p>  <p><b>3</b></p> 	<p><b>2</b></p>  <p><b>4</b></p> 

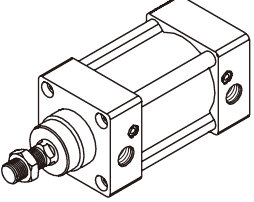

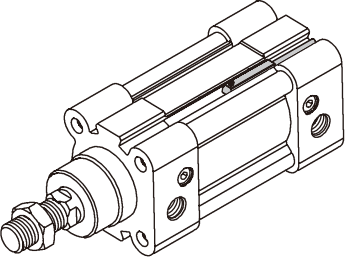
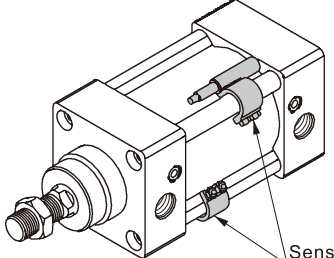
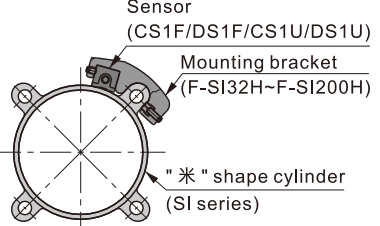
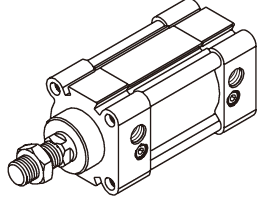
### Sensor for "米" shape cylinder

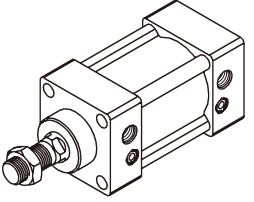
SAI, SAU series will substitute for SI, SU series. And the corresponding sensors have some adjustments as the chart below.

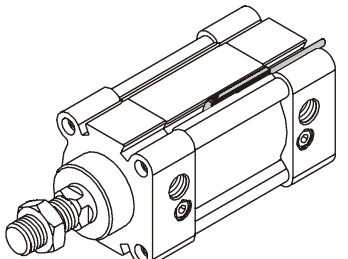
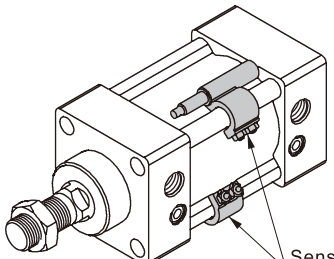
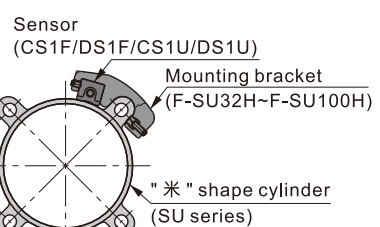
New type(SAI)		Previous type(SI)	
Cylinder and accessory	<p><b>Cylinder</b></p>  <p><b>Sensor</b></p>  <p>CMSE \ DMSE</p>	Cylinder and accessory	<p><b>Cylinder</b></p>  <p><b>Sensor</b></p>  <p>CS1B1 / DS1B1 CS1B2 / DS1B2 CS1B3 / DS1B3 CS1B4 / DS1B4 CS1B5 / DS1B5 CS1B6 / DS1B6 CS1B7 / DS1B7</p>  <p>CS1F/DS1F/CS1U/DS1U + F-SI32H/F-SI40H F-SI50H/F-SI63H F-SI80H/F-SI100H F-SI125H/F-SI160H F-SI200H</p>
Installation		Installation	  <p>Sensor (CS1F/DS1F/CS1U/DS1U) Mounting bracket (F-SI32H~F-SI200H) "米" shape cylinder (SI series)</p> <p>Sensor (CS1B1~B7/DS1B1~B7)</p>
New type(SAU)		Previous type(SU)	
Cylinder and accessory	<p><b>Cylinder</b></p>  <p><b>Sensor</b></p>  <p>DMSG \ CMSG \ EMSG</p>	Cylinder and accessory	<p><b>Cylinder</b></p>  <p><b>Sensor</b></p>  <p>CS1B1 / DS1B1 CS1B2 / DS1B2 CS1B3 / DS1B3 CS1B4 / DS1B4</p>  <p>CS1F/DS1F/CS1U/DS1U + F-SU32H/F-SU40H F-SU50H/F-SU63H F-SU80H/F-SU100H</p>
Installation		Installation	  <p>Sensor (CS1F/DS1F/CS1U/DS1U) Mounting bracket (F-SU32H~F-SU100H) "米" shape cylinder (SU series)</p> <p>Sensor (CS1B1~B4/DS1B1~B4)</p>

### Socket

#### Ordering code

F - EC M08 B 020 - □

① ② ③ ④ ⑤ ⑥



① <b>Category code</b>	F : Accessory			
② <b>Specification code</b>	EC : Connecting Wire			
③ <b>Socket type</b>	M08:M8 socket	M12:M12 socket		
④ <b>Wire type</b>	B: 2-wire type	C:3-wire type		
⑤ <b>Wire length</b>	020: 2 meters	030:3meters	050:5meters	100:10meters
⑥ <b>Additional specification</b>	Blank: General type			

#### Appearance

##### M8 socket

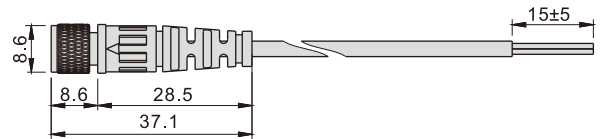
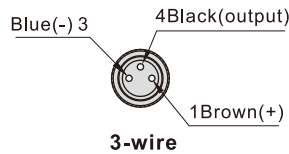
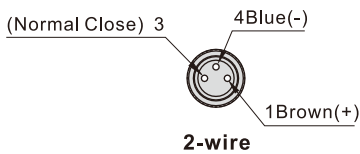

##### M12 socket

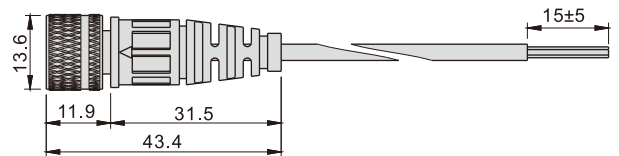
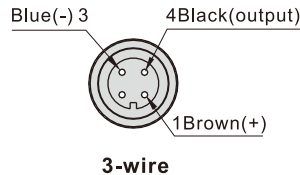
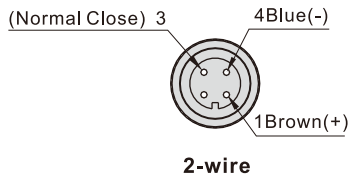

### Instruction

1. Sensor shall not fall down or bear great impact when it is installed.
2. The wire of the Sensor shall not move with the action of cylinder.
3. Clamping torque shall be within the allowable scope when the Sensor is installed(0.15~0.2Nm).
4. Sensor shall be installed in the middle position of the action scope.
5. Sensor wiring:
  - A. The wire is unable to bear repetitive torsion and tension. Please wire an external load before switch the power on.
  - B. No poor insulation in wire.
  - C. Do not wire with power line, high voltage line or use one wiring pipe.
  - D. Pleas wire the circuit correctly base on the circuit diagram.
6. Execute scheduled maintenance by the following guidelines:
  - A. Make sure the sensor is firmly fixed.
  - B. Make sure the wire is intact.
  - C. Make sure that LED indicate the movement of cylinder correctly.
7. Application of environment:
  - A. It is Not allow to use the sensor in the environment with explosive gas.
  - B. Magnetic sensor shall not be used in the environment with external magnetism.
  - C. Magnetic sensor shall not be used in the environment that is always eroded by water.
  - D. Magnetic sensor shall not be used in the environment with oil moisture or chemical substance.
  - E. Magnetic sensor shall not be used in the environment with periodically changing temperature.
  - F. Magnetic sensor shall not be used in the environment with excessively great impact.
  - G. Magnetic sensor shall not be used in the environment with sources of electrical pulse.
  - H. Avoid the environment with accumulated iron power and dense magnetic objects.