

Digitized Automation for a Changing World

# Delta Integrated Elevator Drive IED-S Series



[www.deltaww.com](http://www.deltaww.com)

 **DELTA**  
Smarter. Greener. Together.



Control

# Delta Elevator Drive IED-S Series

Delta, an expert in drive control technology with experience in variable frequency drives, introduces you to a new elevator drive solution that integrates advanced drive and elevator control technology.

The Delta Elevator Drive - IED-S Series is a compact drive that inherits Delta's core drive control technology and includes a vector control function to provide precise control of both induction and permanent-magnet motors for a safe and smooth ride. The comprehensive built-in elevator control technology and smart design minimizes the time and space required for installation and adjustment. Its compact design is durable and supports versatile encoding types. With the optional Active Front End AFE2000 Series and the Power Regenerative Unit REG2000 Series, the IED-S series enables power regeneration and energy-savings, offering you the optimal elevator drive control solution.



Efficiency

- Group control for eight IED-S series without additional group control cards
- Self-diagnosis safety check functions
- Controls up to 64 floors

## Design

- Compact design and suitable for limited or no machine room installation
- Reserved screw holes for users to design their own ideal top covers
- 7-segment LED display for drive status

## Drive

- Supports induction and permanent-magnet motors
- Emergency power supply (EPS) mode
- Supports versatile encoder types

## Tune

- Hoistway auto-tuning detects floor height precisely
- Static parameter auto-tuning with load

## Energy Saving

- Optional Active Front End AFE2000 Series
- Optional Power Regenerative Unit REG2000 Series
- Scheduled lighting and fan operation time control
- Supports standby mode to save energy

- **Direct-Landing Operation** - automatically calculates the speed curve from start to stop by distance for efficient direct stop
- **Rush hour operation** - stops at specific floors to improve peak hour operation efficiency
- **Full-load bypass** - responds to car calls and ignores hall calls when the car reaches its maximum weight capacity

# Contents

## Control Functions 3

Standard  
Door Control  
Protection  
Advanced

## Features and Components 5

## Model Selection 7

Components Allocation  
Model Selection Chart

## Terminals 9

Control Terminals  
Wiring

## Specifications 12

## Characteristics 13

## Accessories 14

## Other Information 17

Dimensions  
Ordering Information  
Model Explanation  
Global Operations

# IED-S Series Control Functions

## Standard Functions

- **Auto-Tuning about Elevator Hoistway**  
Auto-detects total floor height and the switch positions in hoistway
- **Inspection Mode**  
Upon receiving an inspection signal, the system clears all car/hall calls and triggers inspection mode to command the elevator to move to the designated position
- **Zero-Speed Brake for Inspection**  
Ensures elevator brake at zero-speed during inspection mode to reduce the damage to motor brakes
- **Fire Emergency Mode**  
Upon receiving a fire alarm, the system cancels all car/hall calls and commands the elevator to move to the preset designated main landing then open the door
- **Car Lock Mode**  
Once car lock mode is activated, the system cancels all car/hall calls and commands the elevator to move to the preset designated main landing then open the door; the system activates energy-saving mode once the elevator door is closed
- **Attendant Mode**  
Once the attendant mode is activated, the system allows the operator to control the elevator operation
- **Emergency Power Supply (EPS) Mode**  
When a sudden power failure occurs, the system triggers the EPS mode and reactivates, then commands the elevator to move slowly toward the more energy-saving direction and stop at the nearest floor to open the door
- **Call Management for Full Load**  
The system ignores hall calls when the car runs with a full load; these calls are saved and served during the next run when it's not fully loaded or by another car
- **Test Run**  
Automatic elevator test run according to settings
- **Test Run Waiting Time**  
Sets the waiting time between each test run
- **Idling Return**  
The car returns to the designated main landing for standby when no signal comes in after a certain period of time
- **False Car Call Cancellation**  
Double-click the floor button to clear a false car call
- **Auto-Leveling when Power On**  
When the elevator is stuck between floors due to a sudden power failure, it moves to the nearest leveling floor at low speed and opens the door when the power comes back on
- **Homing when Power On**  
When the power is on, the elevator moves to the designated terminal station and opens the door to complete the homing action
- **Non-Service Floor**  
Users can set one or multiple non-service floor(s) in the system and the car will bypass these floor(s)

- **Energy Efficiency**  
The system can switch off the lights and fans if it receives no calls for a certain period of time, and switches them back on upon receiving calls
- **Rush Hour Operation**  
The car stops at specific floors to improve rush hour operation efficiency
- **Car Call Cancellation at the Last Stop**  
When the car arrives at the last car call floor for a trip in one direction, the system automatically cancels all remaining calls in the opposite direction
- **Anti- nuisance Car Call Protection**  
(1) Clears all call signals when the car arrives at the terminal floor  
(2) The elevator auto-detects car loading and compares the car calls numbers; the anti- nuisance car call protection mode triggers if the car call number is more than usual compared to the car loading
- **Leveling Sensor**  
Supports up to 4 leveling sensors for leveling accuracy
- **Selective Control Mode**  
The system can decide to respond to all hall calls, or only to upward or downward hall calls during operation
- **Cartop I/O Terminals**  
Allows flexible wiring and function defining
- **Real-time Status Display**  
The LCD screen displays the status of elevator operation, speed, direction, terminals and other functions
- **Direct Landing**  
Automatically calculates the speed curve from start to stop by distance for an efficient ride

## Door Control

- **Two-Door Mode**  
Supports door control of the front and rear doors
- **Door Control Test**  
Manually controls the door opening and closing for test
- **Safety Detection (Safety Edges / Area Sensors)**
  - **Door Reopen**  
Door reopens when the safety edges / area sensors detect a blockage to ensure passenger safety
  - **Door Block Overtime**  
Cartop alarm activates for warning when the safety edges / area sensors continuously detect a blockage over a certain period of time
- **Door Test when Power On**  
Every time the power is on and the car is detected at the door zone, the system automatically opens and closes the door once as a test



## Door Control

- **Door Opening Duration Setting**  
Users can set different door opening durations for regular mode and handicap mode
- **Door Close Overtime Protection**  
When the system sends out a door closing command but fails to detect a car or hoistway doorlock feedback signal, the door closing command is canceled and the door reopens automatically with an anomaly alarm reported to the system
- **Door Opening at Leveling**  
With the UCMP module, the elevator enables car to open the doors during leveling to save time
- **Door Closing in Advance**  
Allows users to press the door closing button early before the car door reaches its maximum door open limit
- **Independent Car/Hall Control of Front/Rear Doors**  
The system controls the front or rear door via car or hall control panel
- **Door Holding Time**  
User-defined holding time for door opening / closing
- **Door Closing Retry**  
The system waits for a period of time to retry closing the door
- **Door Opening Disabled**  
Disables door opening function during elevator test or inspection
- **Door Opening at Non-Door Zone**  
The door can open at a non-door zone when the elevator is under inspection or maintenance

## Protection

- **Auto-Leveling Protection**  
If the system receives a continuous leveling anomaly signal during operation, the car automatically moves to the nearest leveling floor and stops
- **Contactors Inspection**  
If anomalies of contactors (such as output (motor) contactor, brake contactor, star-delta contactor or others) are detected, the emergency stop function will trigger and stop the elevator immediately to ensure passenger safety
- **Motor Stall Prevention & Encoder Error Protection**  
If abnormal encoder feedback speed or output control speed is detected, the emergency stop function will trigger and stop the elevator immediately to ensure passenger safety
- **Doorlock Failure Protection**  
If a car or hoistway doorlock failure signal is detected, the emergency stop function will trigger and stop the elevator immediately to ensure passenger safety; the elevator will conduct leveling, move to the nearest door zone, and resume normal operation once the doorlock function is retrieved

- **Doorlock Loop Protection**  
If a deceleration signal is detected during door opening while the doorlock circuits are still connected, the elevator will stop and report the anomaly to the system
- **Overload Protection**  
The car door remains open when the capacity is overloaded
- **Car Door Closing Protection**  
If the car door fails to close for three times or closes improperly due to a blockage, the elevator stops automatically to ensure passenger safety; the system will resume normal operation when the blockage is removed or troubleshooting is completed and the signals are detected
- **Encoder Error Inspection**  
Inspects signal failure and feedback signal errors
- **Safety Check Before Mechanical Brake Release**  
The system double-checks if the 3-phase power is short-circuited before releasing the mechanical brake

## Advanced Functions

- **MI/MO Signal Indication**
  - An LCD screen displays MI/MO connector status
  - An LED indicator shows CPU connection status
- **Error Recording (18 Sets)**  
Supports max. 18 sets of error records on CPU
- **Simple Self-Learning of Motor Parameters**  
Simplified motor parameter settings allow fast self-learning by choosing motor types and encoder types for users
- **Hall Call Button Malfunction Diagnosis**
  - A continuous hall call over 20 seconds will be considered a malfunction and ignored & cancelled by the elevator system; meanwhile, the hall call button will blink as a reminder
  - The system will resume normal operation once the issue is resolved
- **Automatic Group Control Disconnection**  
When an elevator fails to respond to hall calls in time, it will automatically disconnect from the group control system without affecting the operation of other elevators
- **False Hall Call Cancellation**  
Allows user-defined hall call cancellation (by double-clicking, long pressing or others)
- **Start / Stop Torque Compensation**  
Built-in start / stop torque compensation technology achieves a smooth start without a load cell, providing a comfortable ride for passengers
- **Deceleration Torque Control**  
The elevator motor current gradually decreases to decelerate for smooth elevator control and lower noise

# Features and Components

## Integrated Elevator Drive & Control IED-S



Delta provides energy feedback devices to help elevators save energy. The Active Front End AFE2000 Series and the Power Regenerative Unit REG2000 Series provide power regeneration functions that collect regenerative energy and convert it into reusable electricity for other facilities. They reduce total energy consumption and lower the temperature in the control room.



### 【Optional】

#### Active Front End AFE2000 Series

1. Power regeneration
2. Power factor Improvement
3. Harmonic suppression



### 【Optional】

#### Power Regenerative Unit REG2000 Series

1. Power regeneration
2. Stable DC bus







## Hall Call/Car Call Display Boards

- EA-FM02MVN02

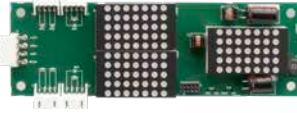

- EA-FM02MBT01

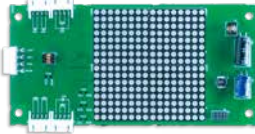

## Cartop Board

- EA-CT01



## Command Board

- EA-CP16

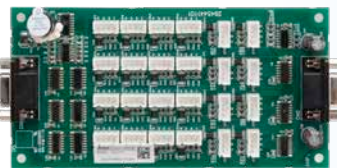

[Optional]

## External Digital Keypad

- KPC-CC01



- Control setting
- Drive setting
- Parameter copy

## Motor Control

- Supports induction motor closed-loop control
- Supports permanent-magnet motor closed-loop control

## Versatile I/O Terminals

- 25 digital input ports
- 8 relay output ports
- 5 high voltage input ports

## Encoder Types

- Incremental
- SIN/COS
- Sick Hiperface
- Heidenhain Endat 2.1

## Direct Landing

- Automatically calculates the speed curve from start to stop by distance for an efficient ride

## Motor Auto-tuning with Load

- Ability to perform auto-tuning with load when the elevator structure is complete
- Measures motor parameters precisely with load
- Measures magnetic declination precisely with load
- Reliable and saves manpower

## Certifications with Compliance

- Complied with CE, UL certifications
- Safe Torque Off (STO) SIL2
- Includes safety circuit certificate for electronic components
- Possesses certificate for self-monitoring subsystem

## LCD Digital Keypad

- Multiple line display allows intuitive operation
- Monitors user-defined physical quantities
- Parameters rapid duplication shortens tuning time
- Built-in real-time clock (RTM)
- Displays in Simplified/Traditional Chinese and English

## Slim and Compact Design

- Slim body design with a min. thickness of 146 mm

# Components Allocation

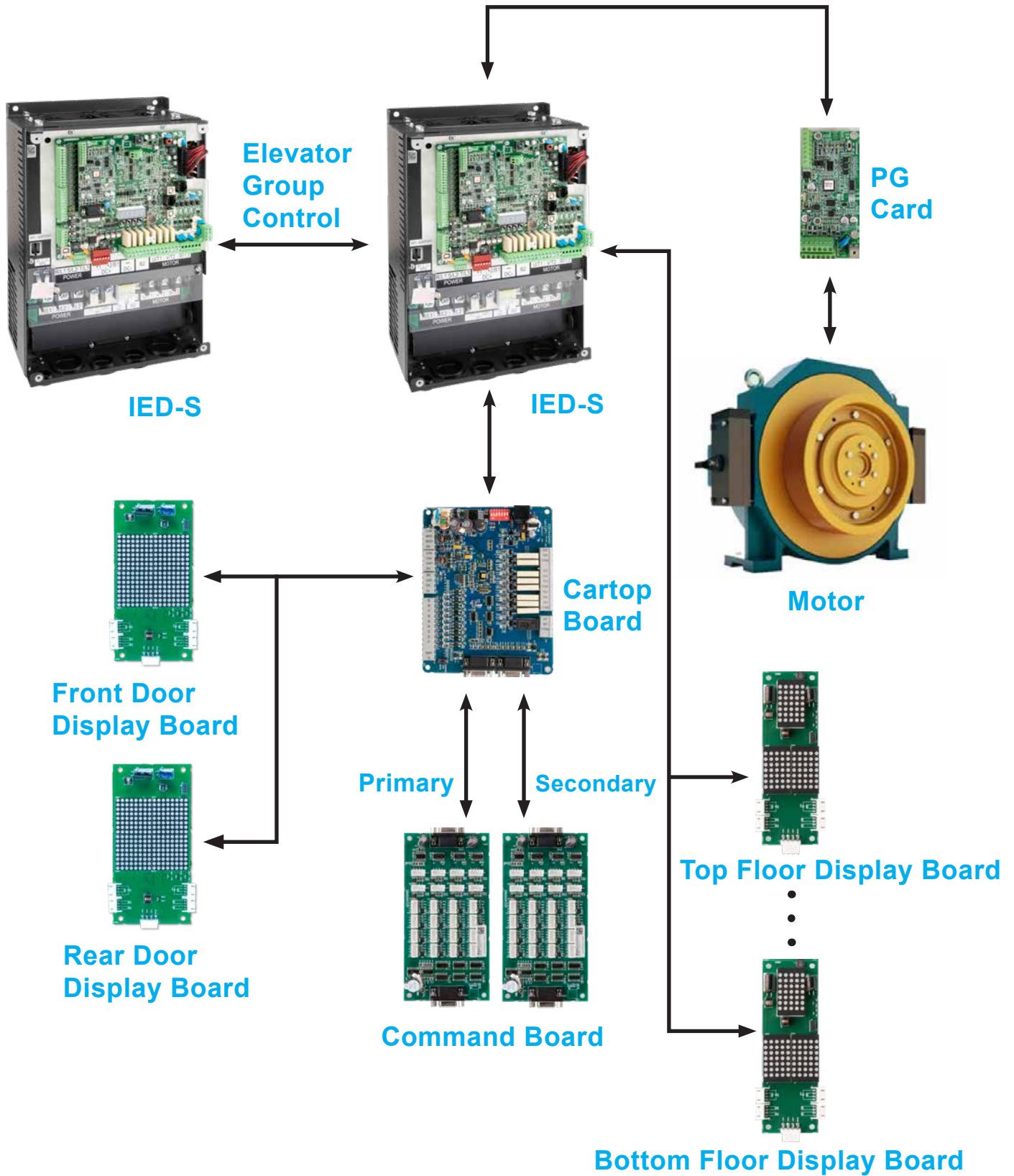



# Model Selection Chart

Unit: PCS

IED-S Model Selection Chart	Floor Range	Cartop Board EA-CT01	Command Board EA-CP16	Command Board Connection Cable (5m) EA-CB05	Command Board Connection Cable (30 cm) EA-CB3C	Car Display Board (Car Call) EA-FM02MVN02 / EA-FM02MBT01	Floor Display Board (Hall Call) EA-FM02MVN02 / EA-FM02MBT01
Front door only	1~16F	1	1	1	0	1	Floor quantity
Front door only	17~32F		2	1	1	1	Floor quantity
Front door only	33~48F		3	1	2	1	Floor quantity
Front door only	49~64F		4	1	3	1	Floor quantity
Front door + Handicap	1~16F		2	2	0	2	Floor quantity X2
Front door + Handicap	17~32F		4	2	2	2	Floor quantity X2
Front door + Rear door	1~16F		2	2	0	2	Floor quantity
Front door + Rear door	17~32F		4	2	2	2	Floor quantity
Front door + Rear door (Two-door)	1~16F		2	2	0	2	Floor quantity X2
Front door + Rear door (Two-door)	17~32F		4	2	2	2	Floor quantity X2
Front door + Rear door + Front handicap	1~16F		3	3	0	3	Floor quantity X2
Front door + Rear door + Front handicap (Two-door)	1~16F		4	4	0	4	Floor quantity X4

\* The quantity of floor display board depends on elevator floor display design. The chart shows the min. floor display board quantity selection. For optional installations (such as head-up display and selected functions), please purchase more floor display boards.

\* The chart only applies to model selection for a single elevator. More elevators require more floor display boards. Please purchase floor display boards for individual needs.

# Control Terminals

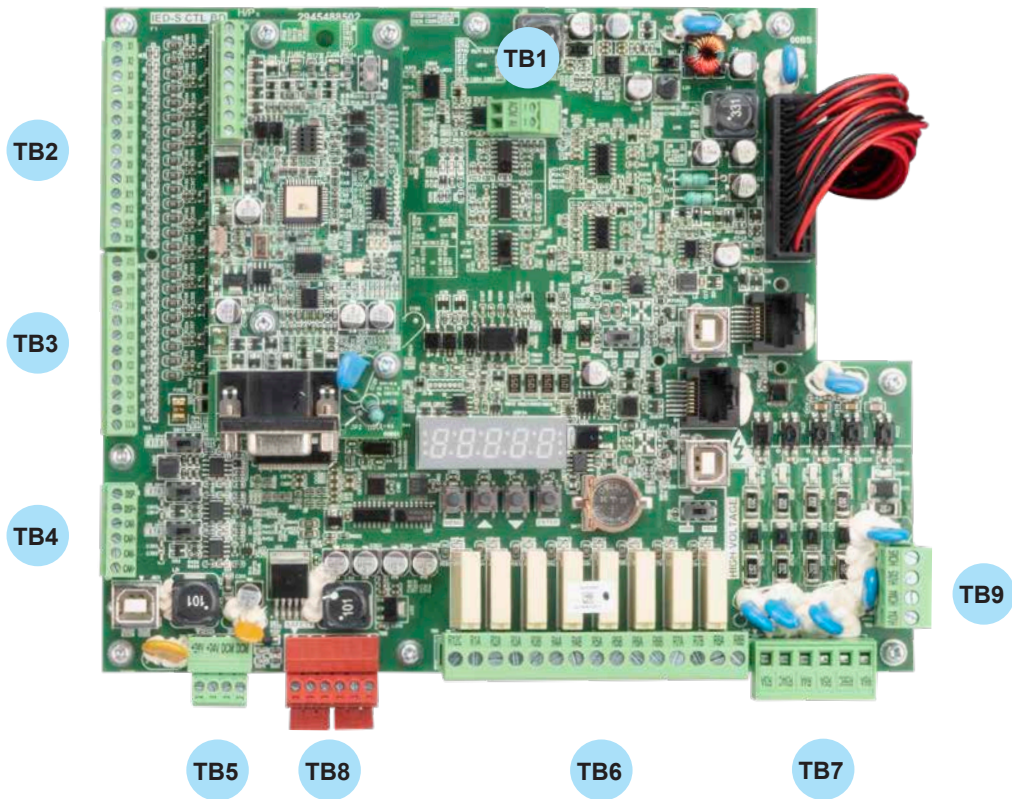

Position	Terminals	Default Settings	Descriptions
TB2	X1	Upper level switch	User-defined functions
	X2	Door zone signal	Non-isolated photocoupler input
	X3	Lower level switch	Voltage > 19V <sub>DC</sub> when the status is guaranteed as ON
	X4	Emergency electrical upward operation	Voltage < 9V <sub>DC</sub> when the status is guaranteed as OFF
	X5	Emergency electrical downward operation	
	X6	Brake-1 contactor detection	
	X7	Brake-2 contactor detection	
	X8	Doorlock bypass detection	
	X9	Inspection	
	X10	Inspection upward	
	X11	Inspection downward	
	X12	Upper limit switch	
	X13	Lower limit switch	
	X14	First one upward forced deceleration	
TB3	X15	First one downward forced deceleration	
	X16	Second one upward forced deceleration	
	X17	Second one downward forced deceleration	
	X18	Brake-1 operation switch	
	X19	Brake-2 operation switch	
	X20	Manual doorlock bypass	
	X21	Inspection from pit	
	X22	Fireman class II	
	X23	Traveling cable insertion	
	X24	Motor temperature overheat switch	
	X25	Operation contactor normal close	
	DCM	Digital signal common terminal	

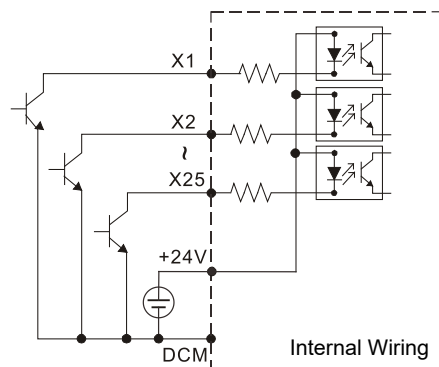

TB5 terminal connects external power (DC 24V) to IED-S



Position	Terminals	Default Settings	Descriptions		
TB4	DSP- DSP+	RS-485 communication port	Hall call communication		
	CAR- CAR+	CANBUS communication port	Group control communication		
	CAN- CAN+	CANBUS communication port	Car communication		
TB5	+24V +24V	External power input +24 V <sub>DC</sub>	24 V <sub>DC</sub> ±10% 800 mA		
	DCM DCM	External power input 0V			
	TB8	STO		Power removal safety function for EN954-1 and IEC/EN61508	
TB1	AI	Analog voltage input port	Range: -10~+10 V <sub>DC</sub> /User-defined functions		
	ACM	Analog control signal common terminal			
TB6	R12C	R1A / R2A connector common terminal	Multi-function relay output port: (1) User-defined functions (2) Resistive load 3A(N.O.)/2A(N.C.) 250 V <sub>AC</sub> /30 V <sub>DC</sub> (3) Inductive load (COS 0.4) 1.0A(N.O.)/0.6A(N.C.) 250 V <sub>AC</sub> /30 V <sub>DC</sub> (4) Conductive with min. load (5 V <sub>DC</sub> , 1 mA)		
	R1A	Operation contactor			
	R2A	Brake-1 contactor			
	R3A R3B	Brake-2 contactor			
	R4A R4B	Fire emergency to main landing			
	R5A R5B	Brake contactor for full voltage			
	R6A R6B	Master fan			
	R7A R7B	Rope gripper contactor			
	R8A R8B	Doorlock bypass contactor			
	TB7	HVX1 HVC1		Safety hatch	User-defined functions Non-isolated photocoupler input Input impedance: 20 kΩ
		HVX2 HVC2		Gate safety hatch	Rated: 110 V <sub>AC</sub> /5.5 mA or 110 V <sub>DC</sub> /5.5 mA
		HVX3 HVC3		Door safety hatch	Voltage > 88 V <sub>DC</sub> when the status of DC is guaranteed as ON
		TB9		HVX4 HVC4	Emergency electrical operation
HVX5 HVC5			External reset device	Voltage > 88 V <sub>AC</sub> when the status of AC is guaranteed as ON Voltage < 50 V <sub>AC</sub> when the status of AC is guaranteed as OFF	



# Wiring

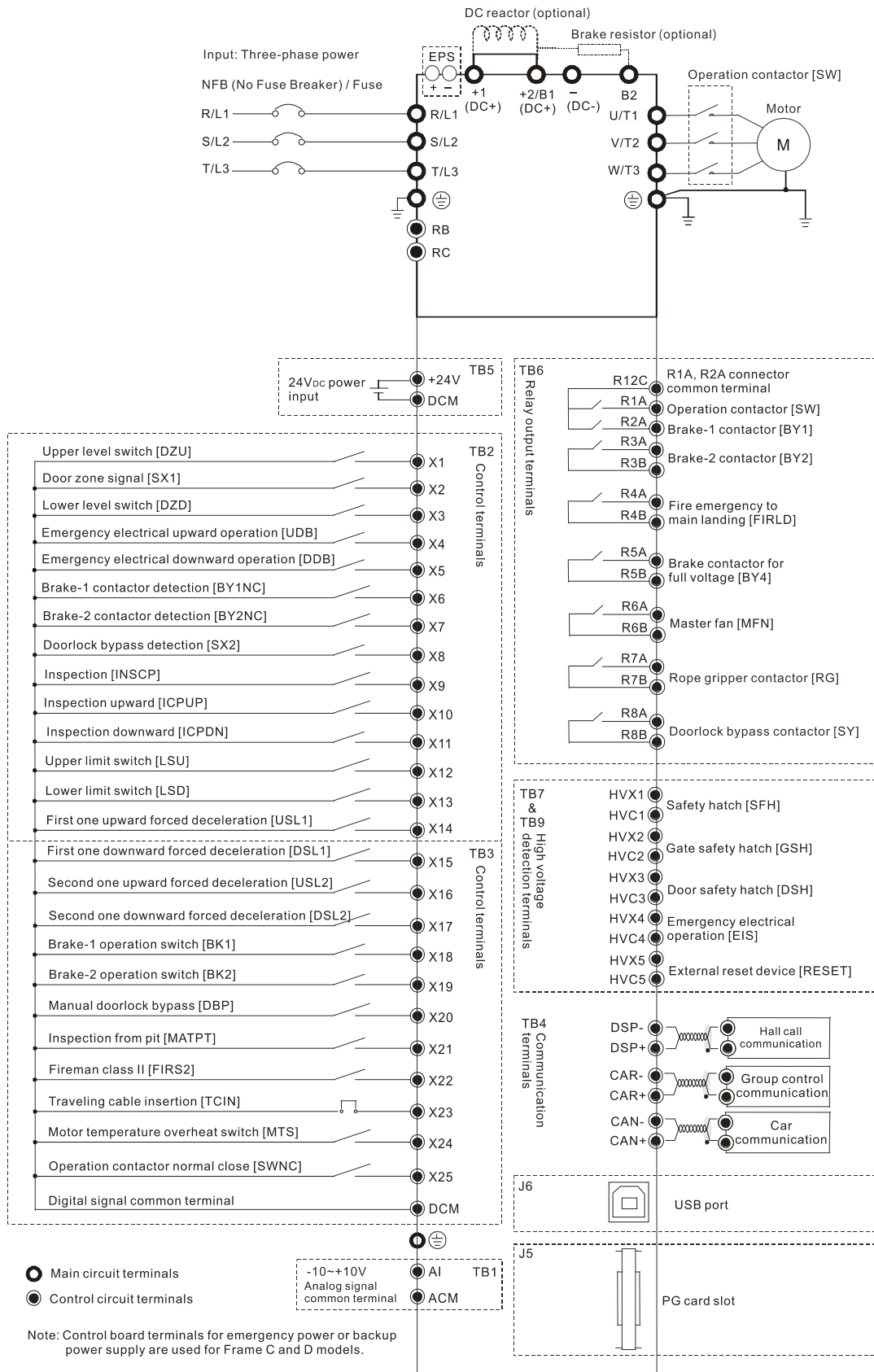





# Specifications

230V Series						
Frame	C			D		
Model IED-___23A	055	075	110	150	185	220
Power range (kW)	5.5	7.5	11	15	18.5	22
Power range (HP)	7.5	10	15	20	25	30
Output	Rated output capacity (kVA)	9.5	12.5	19	25	34
	Rated output current (A)	24	30	45	58	87
	Max. output voltage (V)	Proportional to input voltage				
	Range of output frequency (Hz)	0.00 ~ 299.00				
	Carrier frequency (kHz)	2~15				
	Max. rated output for carrier frequency (kHz)	10			8	
Power supply	Input current (A)	23	30	47	56	90
	Range of voltage (V)	200 ~ 240 / Three-phase				
	Range of frequency (Hz)	50/60				
	Allowable range of voltage variation	±10% (180~264)				
	Allowable range of frequency variation	±5% (47~63)				
Cooling	Fan cooling					
Weight (kg)	8	10	10	13	13	13

460V Series													
Frame	C					D		E					
Model IED-___S43A	055	075	110	150	185	220	300	370	450	550	750		
Power range (kW)	5.5	7.5	11	15	18.5	22	30	37	45	55	75		
Power range (HP)	7.5	10	15	20	25	30	40	50	60	75	100		
Output	Rated output capacity (kVA)	10.4	13.5	18.3	24	30.3	36	46.2	63.7	80	96.4	116.3	
	Rated output current (A)	13	17	23	30	38	45	58	80	100	128	165	
	Max. output voltage (V)	Three-phase input power supply											
	Range of output frequency (Hz)	0.00~299.00											
	Carrier frequency (kHz)	2~15					2~9			2~6			
	Max. rated output for carrier frequency (kHz)	10			8			6					
Power supply	Input current (A)	14	17	24	30	37	47	58	80	100	128	165	
	Range of voltage (V)	380 ~ 480 / Three-phase											
	Range of frequency (Hz)	50/60											
	Allowable range of voltage variation	± 10% (342~528V)											
	Allowable range of frequency variation	± 5% (47~63 Hz)											
Cooling	Fan cooling												
Weight (kg)	8	10	10	10	10	13	14.5	36	36	50	50		

The input/output currents are subject to change on account of input reactor, transformer, wiring, impedance or others.

# Characteristics

Control characteristics	Environmental conditions	FOC + PG, FOC + PM		
	Start torque	Starting torque: 150 % at 0 Hz		
	Speed control range	1:1000		
	Speed control accuracy	± 0.02%		
	Speed response ability	30 Hz		
	Max. output frequency	0.00~299.00 Hz		
	Frequency setting resolution	Digital command ± 0.01 Hz; 0.01 m/s		
	Torque limit	Max. 200% torque current		
	Accel. / decel. time	0.10~1.50 m/s <sup>2</sup>		
	Dynamic braking	The optional dynamic braking reaches 125% braking capacity at 30% ED <b>Note: ED (executive duty)</b>		
	Protection characteristics	Motor protection	Electrical thermal relay protection	
Over-current protection		Over-current protection for 250% rated current		
Ground leakage current protection		Higher than 50% of the drive's rated current		
Overload capability		150% for 60 seconds 180% for 10 seconds		
Over-voltage protection		Over-voltage level: (230 V model) $V_{DC} > 400 V$ (460 V model) $V_{DC} > 800 V$	Low-voltage level: (230 V model) $V_{DC} < 200 V$ (460 V model) $V_{DC} < 400 V$	
Over-voltage protection for input power		Varistor (MOV)		
Overheat protection		Built-in temperature sensor		
Environmental conditions	Protection level	IP00		
	Operation temperature	-10°C~40°C, reaches 50°C with Derating		
	Storage temperature	-20°C~60°C		
	Ambient humidity	Below 90% RH (non-condensing)		
	Vibration	1.0 G at frequency less than 20 Hz; 0.6 G at 20~60 Hz		
	Cooling method	Fan cooling		
	Installation altitude	Altitude 1,000 m or lower, keep from corrosive gases, liquid and dust		
International certification		 		

# Accessories

## ▪ Hall Call & Car Call Display Boards

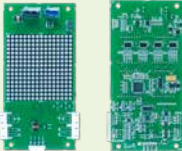
	Terminals	Descriptions
<p><b>EA-FM02MVN02</b> (Vertical Matrix)</p> 	<p><b>J1</b></p>	<p>Modbus communication and power terminals</p>
	<p><b>J2 · J3</b></p>	<p>Upward call / Downward call button interface</p>
<p><b>EA-FM02MBT01</b> (Vertical / Horizontal Matrix)</p> 	<p><b>J4</b></p>	<p>Car lock / Emergency input</p>
	<p><b>J5</b></p>	<p>Car lock / Emergency light signal output</p>

## ▪ Cartop Board

	Terminals	Descriptions
<p><b>EA-CT01</b></p> 	<p><b>I1</b></p>	<p>Cartop inspection switch</p>
	<p><b>I2</b></p>	<p>Inspection upward from car top board</p>
	<p><b>I3</b></p>	<p>Inspection downward from car top board</p>
	<p><b>I4</b></p>	<p>Front door open in position</p>
	<p><b>I5</b></p>	<p>Overload switch</p>
	<p><b>I6</b></p>	<p>Motor temperature overheat switch for front door</p>
	<p><b>I7</b></p>	<p>Front door light sensor</p>
	<p><b>I8</b></p>	<p>Full-load switch</p>
	<p><b>I9</b></p>	<p>Front door safety edges</p>
	<p><b>SAI-SBI</b></p>	<p>Load cell signal input</p>
	<p><b>Ob1-Comb</b></p>	<p>Master fan</p>
	<p><b>Ob2-Comb</b></p>	<p>Arrival chime</p>
	<p><b>Ob3-Comb</b></p>	<p>Overload</p>
	<p><b>Oc1-Comb</b></p>	<p>Car bottom light</p>
	<p><b>Oc2-Comb</b></p>	<p>Doorlock bypass lighting alarm</p>
	<p><b>Oc3-Comb</b></p>	<p>Alarm</p>
	<p><b>Od1-Comb</b></p>	<p>Front door closing</p>
	<p><b>Od2-Comb</b></p>	<p>Front door opening</p>
	<p><b>NC / NO-AM</b></p>	<p>Fan / Lighting output</p>
<p><b>CAN+ / CAN-</b></p>	<p>CAN communication</p>	
<p><b>MOD+ / MOD-</b></p>	<p>Modbus communication</p>	
<p><b>D-SUB connector (J4 / J5)</b></p>	<p>Command board communication</p>	

\* Please refer to the manual for details.



# Accessories

## Command Board

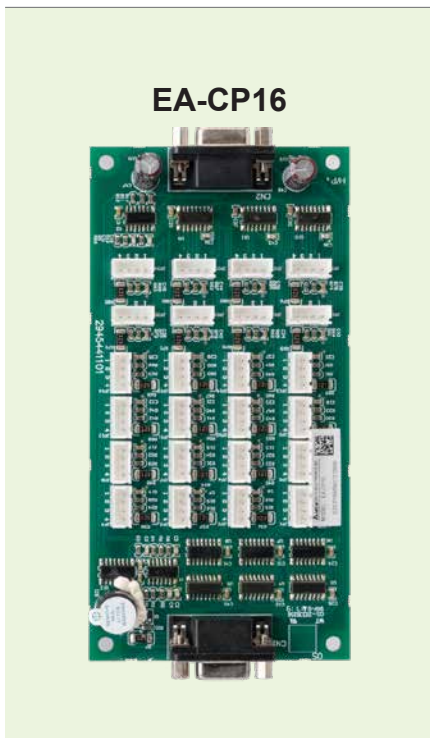

Terminals	Descriptions
JP1~JP16	Floor button input/display output
JP17	Door opening input/display output
JP18	Door closing input/display output
JP19	Door opening holding input/display output
JP20	Direct stop input/display output
JP21	Attendant input
JP22	Direction change input
JP23	Independant operation input
JP24	Fireman input
D-SUB connector (CN1/CN2)	Cartop board communication/Command board expansion

## PG Cards

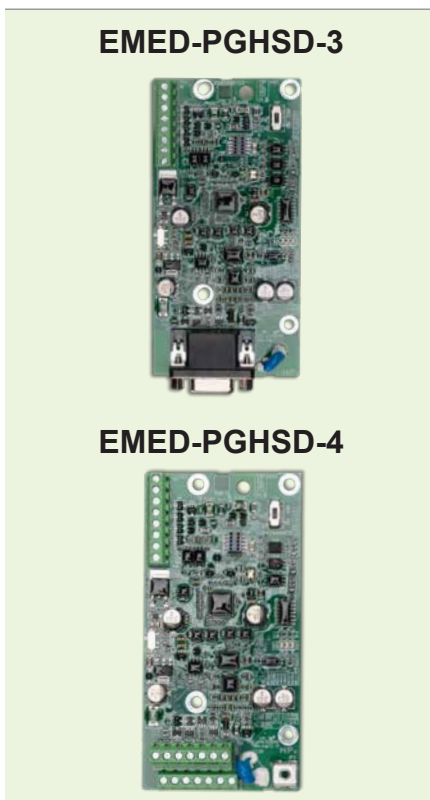

Terminals	Descriptions	
Vin	Port for voltage input (for adjusting the value of voltage amplitude from push-pull pulse output) Max. input voltage: 24 V <sub>DC</sub>	
A/O B/O	Push-pull pulse output signal Max. output frequency: 50 kHz	
GND	Power source common for encoder	
AO/AO BO/BO	Line driver pulse output signal Max. output frequency: 100 kHz	
PGHSD-1	PGHSD-2	Encoder signals - Incremental - SinCos, for example: ERN1387 - Endat 2.1, for example: ECN413 / ECN1313 - SICK HYPERFACE, for example: SRS50 / 60
D-SUB Connector (J3)	Terminal Block Connector (TB2)	
SW1		Internal / External power switch for frequency divided output
SW2		Switch between encoder power 5V/8V

▪ PG Card

EMED-PGABD-2



Terminals	Descriptions
<b>Vin</b>	Port for voltage input to adjust the amplitude of output voltage at terminal A/O and terminal B/O
<b>A/O B/O</b>	Output signal of the push-pull frequency divider Factory setting: Output amplitude is about +24 V. Use SW2 to cut off the internal default power and input required power (i.e. output voltage's amplitude) Max. output frequency: 100 kHz Frequency dividing range: 1 ~ 31 Hz
<b>GND</b>	Common ground terminal connecting to the host controller and the motor drive
<b>AO/AO BO/BO</b>	Line driver pulse output signal Max. output frequency: 150 kHz Frequency dividing range: 1 ~ 31 Hz
<b>VP</b>	Power output of encoder <i>Note: Use SW1 to set up output voltage</i> Voltage: +5V (±0.5V) or +12V (±1V) Current: max. 200 mA
<b>0V</b>	Encoder common terminal
<b>A/A B/B Z/Z</b>	Incremental encoder signal input (line driver, voltage, push-pull, open collector) <i>Note: Different input signals need different wiring methods. See the user manual for wiring diagrams.</i> Max. input frequency: 150 kHz
<b>U/U V/V W/W</b>	Absolute encoder signal input (line driver, voltage, push-pull, open collector) <i>Note: Different input signals need different wiring methods. See the user manual for wiring diagrams.</i> Max. input frequency: 150 kHz
<b>SW1</b>	Switch between encoder power 5V/12V
<b>SW2</b>	Switch between OPEN-C/LINE-D
<b>SW3</b>	Internal/External power switch for frequency divided output



# Dimensions

## ■ Frame C

IED055S23A | IED075S23A | IED110S23A | IED055S43A

IED075S43A | IED110S43A | IED150S43A | IED185S43A

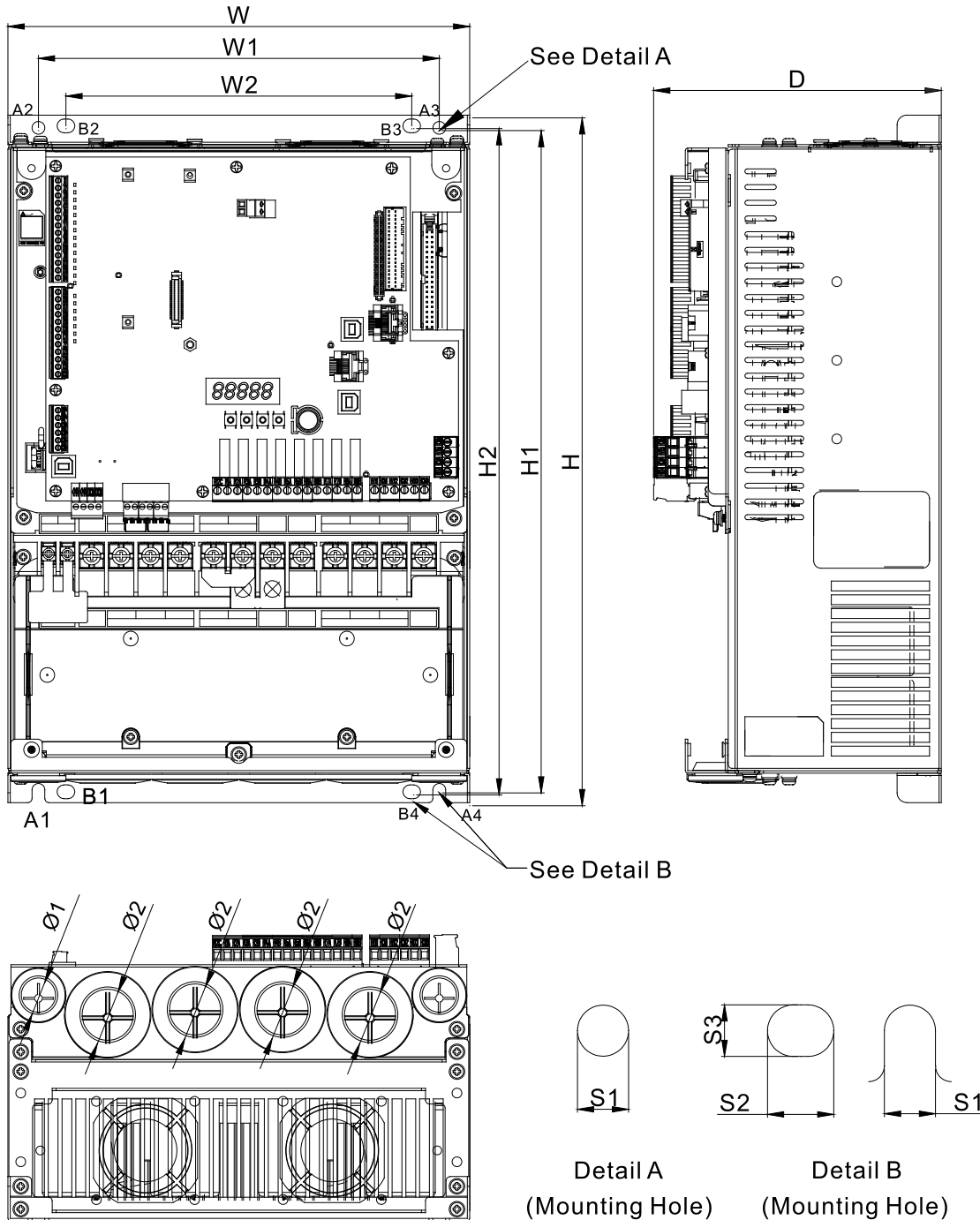

Frame		W	W1	W2	H	H1	H2	D	S1	S2	S3	Ø1	Ø2
C	mm	235	204	176	350	337	339	146.4	6.5	9	7	19.7	28.3
	inch	9.25	8.03	6.93	13.78	13.27	13.35	5.76	0.26	0.35	0.28	0.78	1.11

Notes:  
A1~A4, B1~B4 are used for screwdriver installation.  
B1~B4 are used for sleeve installation.



■ Frame D

IED150S23A | IED185S23A | IED220S23A | IED220S43A | IED300S43A

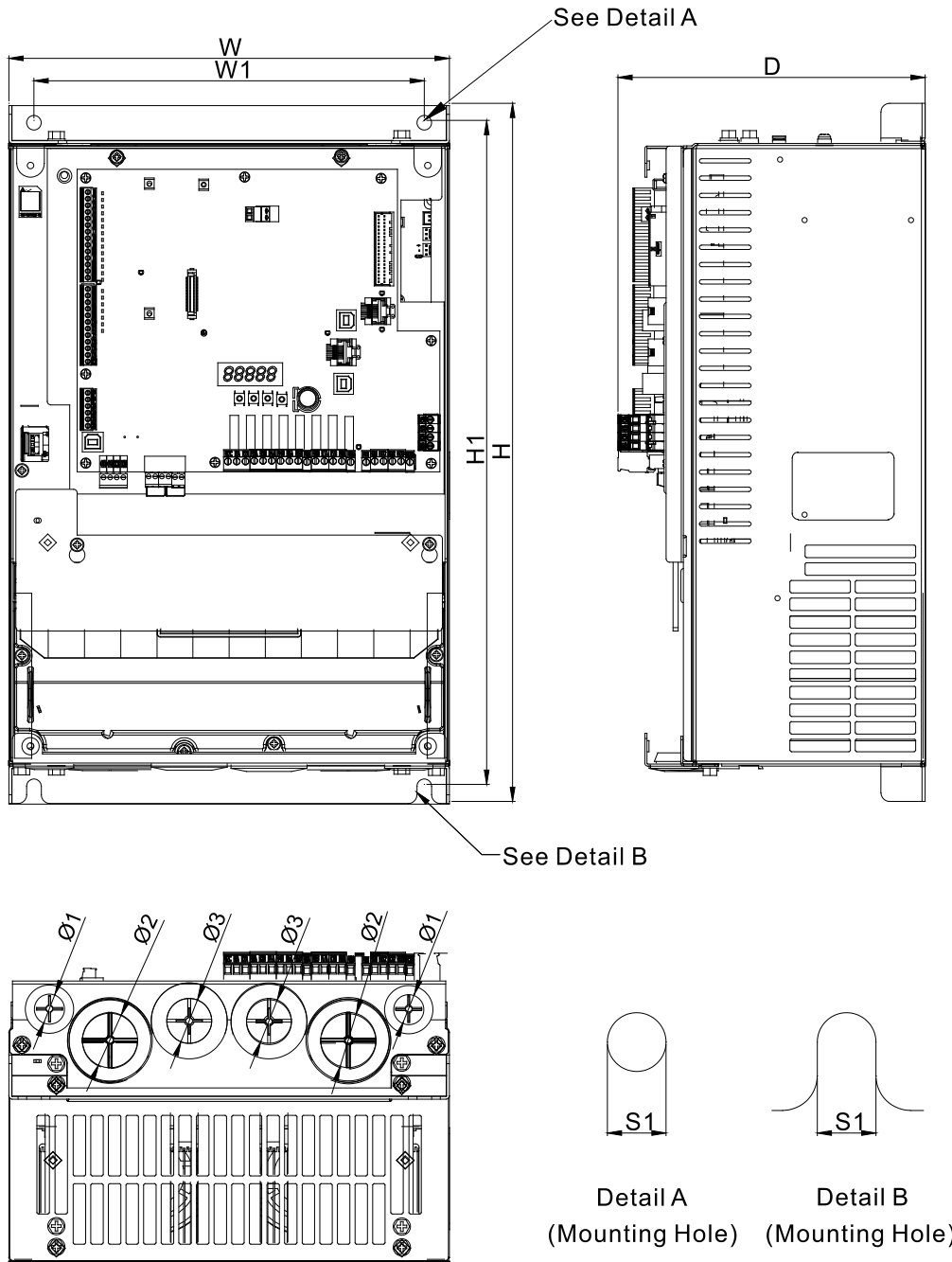

Frame	W	W1	H	H1	D	S1	Ø1	Ø2	Ø3	
D	mm	255	226	403.8	384	177.9	8.5	17.5	32	26
	inch	10.04	8.9	15.9	15.12	7	0.33	0.69	1.26	1.02

Notes:  
A1~A4, B1~B4 are used for screwdriver installation.  
B1~B4 are used for sleeve installation.

# Dimensions

■ Frame E

IED370S43A | IED450S43A | IED550S43A | IED750S43A

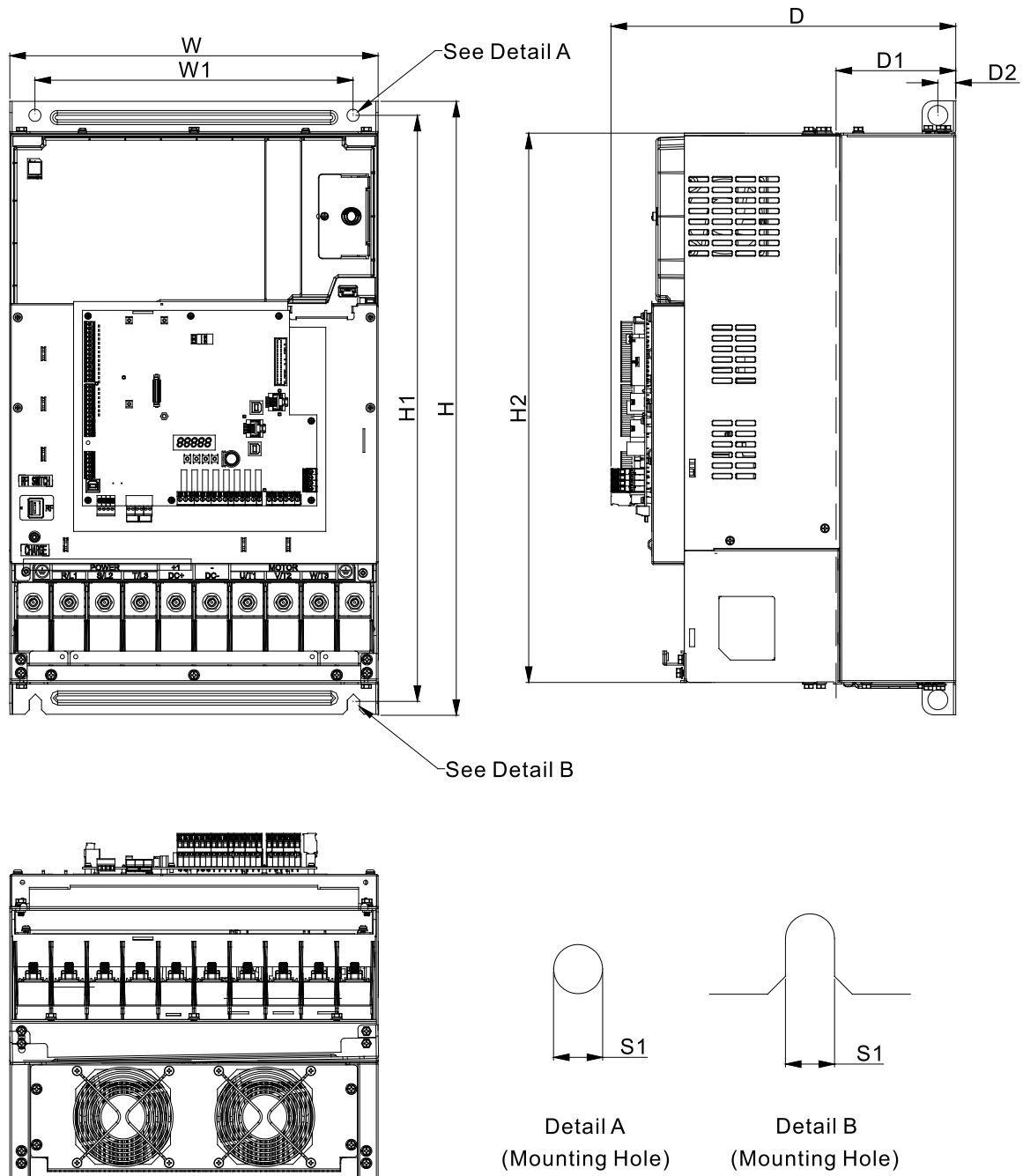

Frame		W	W1	H	H1	H2	D	D1	D2	S1	S2
E	mm	330	285	550	525	492	308.9	107.2	16	11	18
	inch	12.99	11.22	21.65	20.67	19.37	12.16	4.22	0.63	0.43	0.71

Notes:  
D1: This dimension is for flange mounting application reference.

# Ordering Information

IED-S Models	
IED055S23A	Three-phase 220 V / 5.5 kW
IED075S23A	Three-phase 220 V / 7.5 kW
IED110S23A	Three-phase 220 V / 11 kW
IED150S23A	Three-phase 220 V / 15 kW
IED185S23A	Three-phase 220 V / 18.5 kW
IED220S23A	Three-phase 220 V / 22 kW
IED055S43A	Three-phase 460 V / 5.5 kW
IED075S43A	Three-phase 460 V / 7.5 kW
IED110S43A	Three-phase 460 V / 11 kW
IED150S43A	Three-phase 460 V / 15 kW
IED185S43A	Three-phase 460 V / 18.5 kW
IED220S43A	Three-phase 460 V / 22 kW
IED300S43A	Three-phase 460 V / 30 kW
IED370S43A	Three-phase 460 V / 37 kW
IED450S43A	Three-phase 460 V / 45 kW
IED550S43A	Three-phase 460 V / 55 kW
IED750S43A	Three-phase 460 V / 75 kW

Accessories	
EMED-PGABD-2	PG card, suitable for encoder types: A/B/Z & U/V/W absolute encoder
EMED-PGHSD-3	Encoder types: - Incremental - SinCos, for example: ERN1387 - Endat 2.1, for example: ECN413/ECN1313 - SICK HYPERFACE, for example: SRS50 / 60
EMED-PGHSD-4	
EA-FM02MVN02	Floor display board: 2 digits, 7-steps display, vertical display board, 5x7 dot-matrix display
EA-FM02MBT01	Floor display board: 2 digits, 7-steps display, vertical display board, 8x8 dot-matrix display
EA-CT01	Cartop board, cartop command board
EA-CP16	Command board, supports button board of 16 floors
EA-CB05	Communication cable, connects and communicates within command boards used in an elevator as well as command board and cartop board Length: 5,000 mm ± 50 mm; Interface: D-SUB 9PIN
EA-CB3C	Communication cable, connects and communicates within command boards used in an elevator as well as command board and cartop board Length: 300 mm ± 10 mm; Interface: D-SUB 9PIN
KPC-CC01	Digital control keypad

# Model Explanation



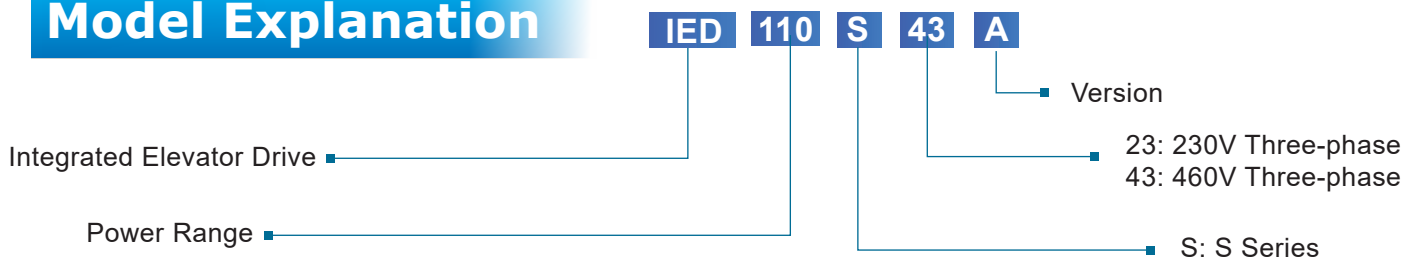

# Global Operations

## ASIA (Taiwan)



Taoyuan Technology Center (Green Building)



Taoyuan Plant 1



Tainan Plant (Diamond-rated Green Building)

## ASIA (China)



Wujiang Plant 3



Shanghai Office



### ASIA (Japan)



Tokyo Office

### ASIA (India)



Rudrapur Plant  
(Green Building)

### EUROPE



Amsterdam, the Netherlands

### AMERICA



Research Triangle Park, U.S.A.

▲ 6 Factories   ■ 117 Branch Offices   ● 13 R&D Centers   ■ 915 Distributors





Smarter. Greener. Together.

## Industrial Automation Headquarters

### Taiwan: Delta Electronics, Inc.

Taoyuan Technology Center  
No.18, Xinglong Rd., Taoyuan District,  
Taoyuan City 33068, Taiwan  
TEL: +886-3-362-6301 / FAX: +886-3-371-6301

## Asia

### China: Delta Electronics (Shanghai) Co., Ltd.

No.182 Minyu Rd., Pudong Shanghai, P.R.C.  
Post code : 201209  
TEL: +86-21-6872-3988 / FAX: +86-21-6872-3996  
Customer Service: 400-820-9595

### Japan: Delta Electronics (Japan), Inc.

Industrial Automation Sales Department  
2-1-14 Shibadaimon, Minato-ku  
Tokyo, Japan 105-0012  
TEL: +81-3-5733-1155 / FAX: +81-3-5733-1255

### Korea: Delta Electronics (Korea), Inc.

1511, 219, Gasan Digital 1-Ro., Geumcheon-gu,  
Seoul, 08501 South Korea  
TEL: +82-2-515-5305 / FAX: +82-2-515-5302

### Singapore: Delta Energy Systems (Singapore) Pte Ltd.

4 Kaki Bukit Avenue 1, #05-04, Singapore 417939  
TEL: +65-6747-5155 / FAX: +65-6744-9228

### India: Delta Electronics (India) Pvt. Ltd.

Plot No.43, Sector 35, HSIIDC Gurgaon,  
PIN 122001, Haryana, India  
TEL: +91-124-4874900 / FAX: +91-124-4874945

### Thailand: Delta Electronics (Thailand) PCL.

909 Soi 9, Moo 4, Bangpoo Industrial Estate (E.P.Z),  
Pattana 1 Rd., T.Phraksa, A.Muang,  
Samutprakarn 10280, Thailand  
TEL: +66-2709-2800 / FAX: +66-2709-2827

### Australia: Delta Electronics (Australia) Pty Ltd.

Unit 20-21/45 Normanby Rd., Notting Hill Vic 3168, Australia  
TEL: +61-3-9543-3720

## Americas

### USA: Delta Electronics (Americas) Ltd.

5101 Davis Drive, Research Triangle Park, NC 27709, U.S.A.  
TEL: +1-919-767-3813 / FAX: +1-919-767-3969

### Brazil: Delta Electronics Brazil

Rua Itapeva, 26 - 3º, andar Edifício Itapeva,  
One - Bela Vista 01332-000 - São Paulo - SP - Brazil  
TEL: +55-12-3932-2300 / FAX: +55-12-3932-237

### Mexico: Delta Electronics International Mexico S.A. de C.V.

Gustavo Baz No. 309 Edificio E PB 103  
Colonia La Loma, CP 54060  
Tlalnepantla, Estado de México  
TEL: +52-55-3603-9200

## EMEA

### EMEA Headquarters: Delta Electronics (Netherlands) B.V.

Sales: Sales.IA.EMEA@deltaww.com  
Marketing: Marketing.IA.EMEA@deltaww.com  
Technical Support: iatechnicalsupport@deltaww.com  
Customer Support: Customer-Support@deltaww.com  
Service: Service.IA.emea@deltaww.com  
TEL: +31(0)40 800 3900

### BENELUX: Delta Electronics (Netherlands) B.V.

Automotive Campus 260, 5708 JZ Helmond, The Netherlands  
Mail: Sales.IA.Benelux@deltaww.com  
TEL: +31(0)40 800 3900

### DACH: Delta Electronics (Netherlands) B.V.

Coesterweg 45, D-59494 Soest, Germany  
Mail: Sales.IA.DACH@deltaww.com  
TEL: +49(0)2921 987 0

### France: Delta Electronics (France) S.A.

ZI du bois Challand 2, 15 rue des Pyrénées,  
Lisses, 91090 Evry Cedex, France  
Mail: Sales.IA.FR@deltaww.com  
TEL: +33(0)1 69 77 82 60

### Iberia: Delta Electronics Solutions (Spain) S.L.U

Ctra. De Villaverde a Vallecas, 265 1º Dcha Ed.  
Hormigueras – P.I. de Vallecas 28031 Madrid  
TEL: +34(0)91 223 74 20

Carrer Llacuna 166, 08018 Barcelona, Spain

Mail: Sales.IA.Iberia@deltaww.com

### Italy: Delta Electronics (Italy) S.r.l.

Via Meda 2-22060 Novedrate(CO)  
Piazza Grazioli 18 00186 Roma Italy  
Mail: Sales.IA.Italy@deltaww.com  
TEL: +39 039 8900365

### Russia: Delta Energy System LLC

Vereyskaya Plaza II, office 112 Vereyskaya str.  
17 121357 Moscow Russia  
Mail: Sales.IA.RU@deltaww.com  
TEL: +7 495 644 3240

### Turkey: Delta Greentech Elektronik San. Ltd. Sti. (Turkey)

Şerifali Mah. Hendem Cad. Kule Sok. No:16-A  
34775 Ümraniye – İstanbul  
Mail: Sales.IA.Turkey@deltaww.com  
TEL: + 90 216 499 9910

### MEA: Eltek Dubai (Eltek MEA DMCC)

OFFICE 2504, 25th Floor, Saba Tower 1,  
Jumeirah Lakes Towers, Dubai, UAE  
Mail: Sales.IA.MEA@deltaww.com  
TEL: +971(0)4 2690148